

PART# BR7-UC2



BlendMount[®]
Innovative Mounting Solutions

Uniden[®]

**INSTALLATION INSTRUCTIONS FOR THE UNIDEN R7
SPRING CLIP REPLACEMENT WITH 5/8" LONG SLOT**

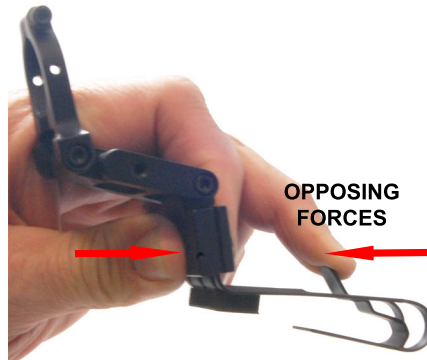
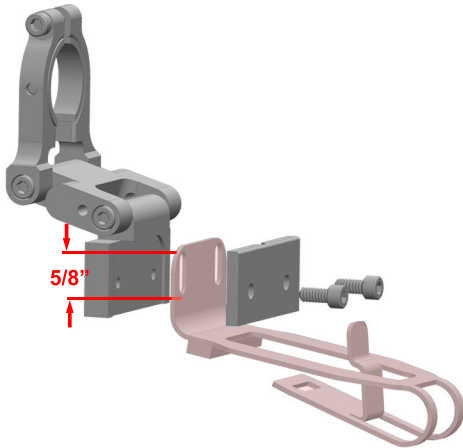

STEP 1 - Install and remove your radar detector (RD) onto the mount before installing it on the rear view mirror so you can observe how the spring clip functions. To release tension from the spring clip, simply squeeze the release tab and the back side of the mount together as shown above. This will lower the bottom portion of the spring clip allowing you to slide the RD on and off the mount. To install the RD, squeeze the release tab and slide the clip into the RD until it locks into position. To remove the RD, squeeze the release tab with one hand and press the RD release button with the other hand. Once the RD slides about 1/8" you can let go of the RD release button and slide the RD off of the spring clip. When used properly, the spring clip avoids putting excessive pressure on the mirror stem when installing and removing the RD.

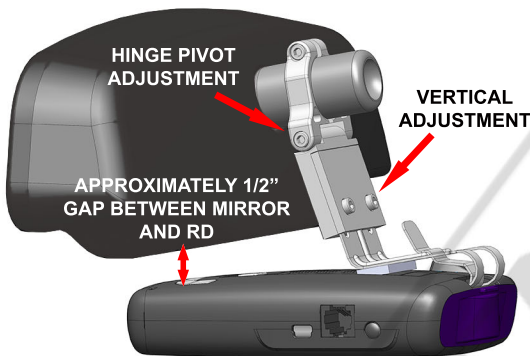

STEP 3 - If the RD is too close to the bottom of the mirror, You may access the buttons on top of the RD by gently pushing downward on the front of the RD with one finger and push the desired button with another finger. Then allow the RD to return to it's original position by gently letting it spring upward. When accessing the buttons, be sure to push the RD downward just enough for your finger to fit between the RD and mirror. **Do not push down more than what is needed.**

STEP 2 - Install RD onto the mount. Make necessary adjustments as shown above. Using vertical adjustment, we recommend you adjust RD so there is approximately 1/2" gap between bottom of mirror and top of the RD. After all adjustments are made, be sure to check that hinge pivot and vertical adjustment screws are tight. The screw on the very top of the mount should be tightened last. Grab long arm of the allen wrench to assure that screws are securely tightened. You will not strip out the tapped holes in the aircraft grade aluminum.



**SCAN THE QR CODE WITH
YOUR SMART PHONE TO
VIEW INSTALL VIDEOS**

NOTE : This mount can get extremely hot when sitting in direct sunlight. If you intend to remove your RD frequently, you may want to install the two gray "TOUCH STRIPS" included in the tool kit. Place them where your fingers make contact with the mount. They may be trimmed with a blade or knife.

FOR MORE INFO VISIT www.blendmount.com/videos



BlendMount - US PATENT # D625,580 S, D656,811 S, D653,980 S, D690,245 S, D690,246 S, D690,247 S and other patents pending