

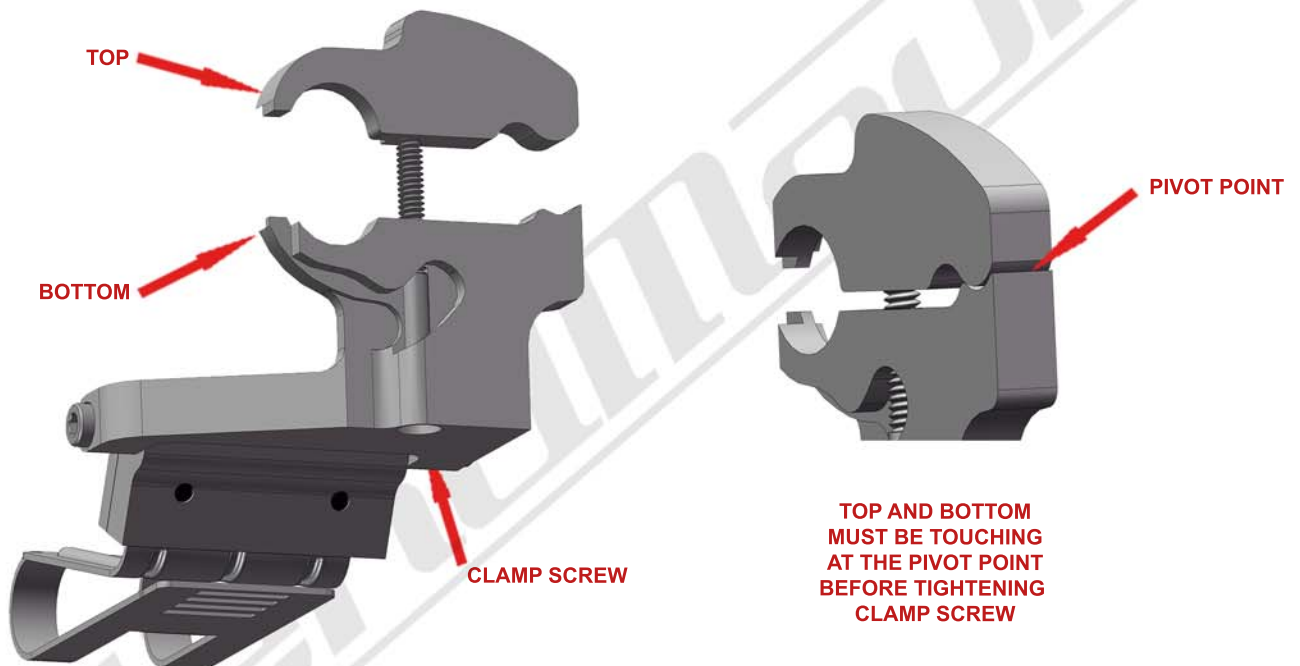

BMW rear view mirrors have minimal clearance between the back side of the mirror and the mirror stem. It is very important that this mount is installed correctly to ensure mirror adjustability is retained. PLEASE READ THESE INSTRUCTIONS THOROUGHLY BEFORE INSTALLING THIS MOUNT



BEFORE INSTALLING THIS MOUNT ON YOUR MIRROR observe how the spring clip functions. **When used properly, the spring clip avoids putting excessive pressure on the mirror when installing and removing the radar detector (RD).** To release tension from the spring clip, simply squeeze the tab and the back side of the mount together. This will lower the bottom portion of the spring clip allowing you to slide the RD on and off the mount. Push the RD Release button and slide the RD onto the Spring Clip as far as it will go. Then release both the Tab and the Release Button. Slide the RD toward you just slightly until you hear it lock into position. Install and remove the RD a few times before installing the mount on your mirror.



STEP 1 - Loosen the clamp screw and remove the top of the mount. Reattach the top by tightening the clamp screw just **two revolutions**. This will provide the necessary clearance to slide the mount over the mirror stem as shown above.

STEP 2 - BEFORE TIGHTENING THE CLAMP SCREW, MAKE SURE THE TOP AND BOTTOM PIECES ARE TOUCHING AT THE PIVOT POINT. If you can not get them to touch at the pivot point, you have an **incompatible mirror type** for this mount.



STEP 3 - If the pivot points are touching, tighten the clamp screw until the top and bottom pieces are **slightly snug** around the mirror stem. You should still be able to rotate and move the mount along the mirror stem.



STEP 4 - Position the mount towards the front of the vehicle as far as it will go. Rotate the mount so it is parallel with the bottom of the mirror. Tighten the clamp screw until the mount is securely attached to the mirror stem. Do not over tighten the clamp screw.

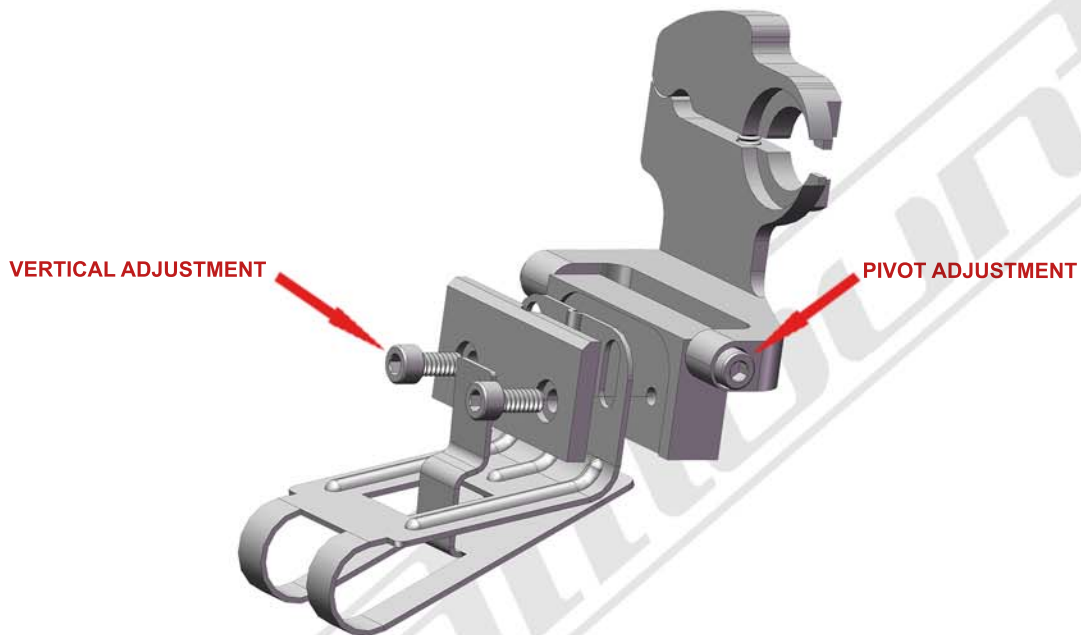

STEP 5 - Install your radar detector onto the mount. Use the adjustments shown above to adjust the RD to your desired position. We recommend adjusting the RD as close to the bottom of your mirror as you can. Be sure to tighten the vertical and pivot adjustment screws after the adjustments are made. For the Pivot adjustment, grab the long arm of the allen wrench for maximum leverage. You will not strip the threaded holes in the aircraft grade aluminum.

CAUTION

DO NOT use this mount if it interferes with the adjustability or the operation of your rear view mirror in any way.

DO NOT use this mount if the radar detector creates an unsafe viewing obstruction.

DO NOT ATTEMPT TO MODIFY THIS PRODUCT. Consult the manufacturer for assistance.

All BlendMount products are accompanied with detailed installation instructions and adjustment tips. You are encouraged to contact customerservice@blendmount.com or call J28 Design at 1-888-497-8388 for further assistance.

Check the BlendMount Forum for installation tips and some vehicle specific installs.
www.blendmount.com

Your feedback is very important to us. Please email any questions or comments you have to customerservice@blendmount.com